

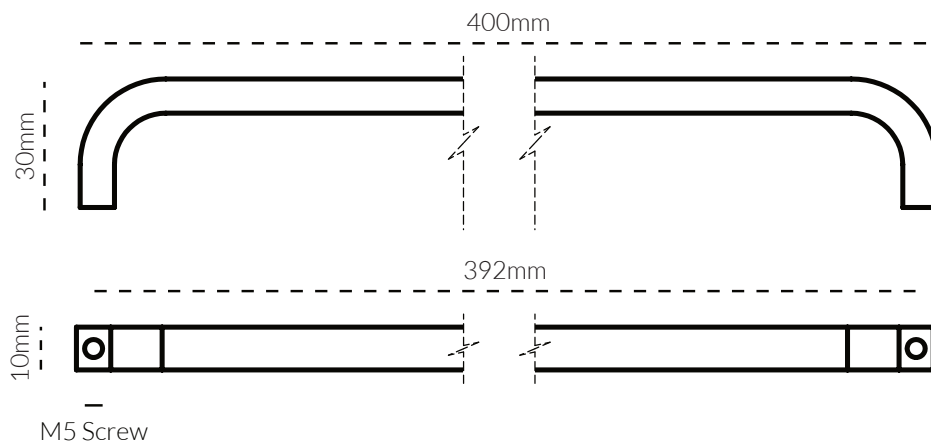







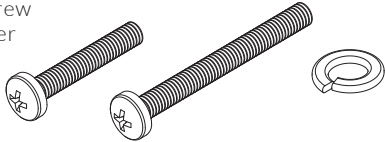

HARDWARE | CURVE PULL 40CM

TECH SPEC

SPECIFICATIONS



FINISH	SKU	FIXINGS ALSO INCLUDED
 Natural Brass	4051-400-US4	2x M5 * 25mm screw 2x M5 * 40mm screw 4x M5 spring washer 
 Aged Brass	4051-400-AB	
 Bronze	4051-400-BR	
 Matte Black	4051-400-US19	
 Matte White	4051-400-W	
 Brushed Nickel	4051-400-BN	

CARE INSTRUCTIONS

Wipe with damp cloth and avoid using any chemicals.