

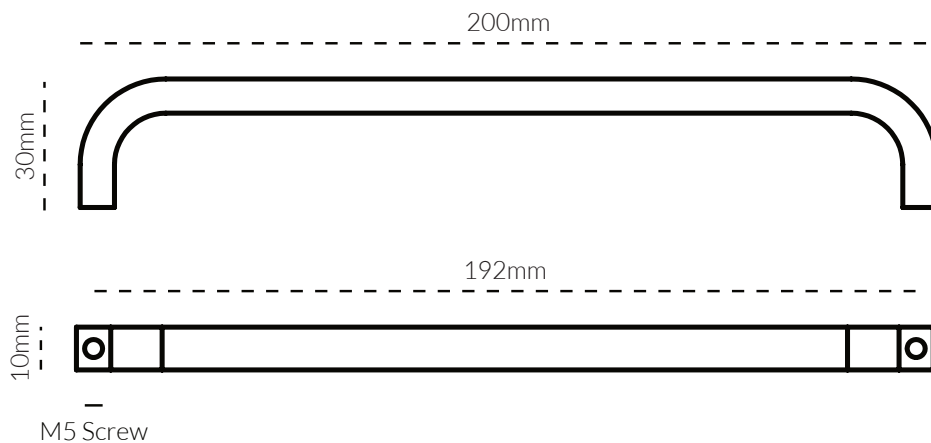







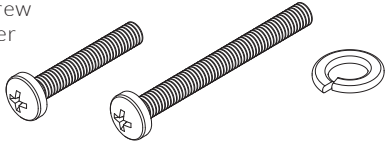

HARDWARE | CURVE PULL 20CM

TECH SPEC

SPECIFICATIONS



FINISH	SKU	FIXINGS ALSO INCLUDED
 Natural Brass	4051-200-US4	 <p>2x M5 * 25mm screw 2x M5 * 40mm screw 4x M5 spring washer</p>
 Aged Brass	4051-200-AB	
 Bronze	4051-200-BR	
 Matte Black	4051-200-US19	
 Matte White	4051-200-W	
 Brushed Nickel	4051-200-BN	

CARE INSTRUCTIONS

Wipe with damp cloth and avoid using any chemicals.